

SW SERIES VERTICAL SLIDING SERVICE WINDOWS (SERIES 1000 THRU 1400)

INSTALLATION INSTRUCTIONS

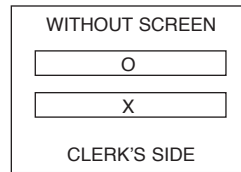

Three series of Vertical Sliding Windows are available. For diagrams shown here, designations are as follows:
O = Fixed Panel
X = Sliding Panel



SERIES 1000

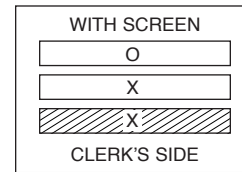

SERIES 1200

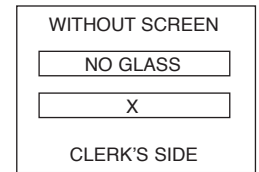

SERIES 1400

IMPORTANT: PLEASE READ BEFORE INSTALLING THE WINDOW

The following instructions will reduce your chances of experiencing problems during installation, and ensure smooth, trouble-free operation of these windows.

The SW Series Vertical Sliding Service Window is designed for low to moderate use (less than 50 uses per day). Call for more information before installing if usage exceeds this.

INSTALLATION REQUIREMENTS

The SW Series Vertical Sliding Service Window is designed with an obstruction free sill that allows for convenient transactions. Installing this window by the instructions listed below, will ensure that the window operates properly.

1. When the window is in the closed position with latches engaged, sealing is achieved as long as the pile weatherstrip is making contact with the counter or sill. This means that the bottom of the side jambs must be in contact with the counter or sill to achieve a proper seal.
2. It is also important that the distance between one side jamb to the other, is the same from the top of the window to the bottom and all areas in between. This will assure even and constant operating pressure to the sliding panel.
3. The two above requirements must be met at the time of installation. If the counter/sill is level and the opening is plumb, there should be no problem in meeting the requirements (proceed to Installation Procedures for a Level and Plumb Opening with Proper Clearances). However, if the counter/sill is not level or the opening is out of plumb, adjustments will have to be made (proceed to Installation Procedures for Out of Square Openings).

WINDOW CHECKLIST

1. Remove the window from package and inspect. Advise CRL immediately if any damage is noted.
2. Before opening and closing the window, read the Latching Information attached.
3. Re-tighten all the screws, as some may have loosened during transit.
4. Bench test this window before installation.
5. Do not apply lubricant to jambs or edges of sliding panel (contact CRL for more information).

SW SERIES VERTICAL SLIDING SERVICE WINDOWS (SERIES 1000 THRU 1400)

INSTALLATION INSTRUCTIONS

MATERIALS INCLUDED

Window and Components

MATERIAL RECOMMENDED (NOT INCLUDED)

- | | |
|--|---|
| 1. CRL Cat. No. 1550 Lint Free Shop Towels | 3. CRL Cat. No. 199 Utility Knife |
| 2. CRL Cat. No. NWS9 Tapered Wood Shims | 4. CRL Cat. No. 1973 Glass Cleaner |
| | 5. CRL Cat. No. M64 Construction Sealant (Select Color) |

INSTALLATION PROCEDURES

(FOR A LEVEL AND PLUMB OPENING WITH PROPER CLEARANCES)

1. Check the opening to be sure it is square and has the proper clearances.
 - a) Wall opening width must be 1/4" (minimum) wider than the window width.
 - b) Wall opening height must be 1/8" (minimum) higher than the window height.
2. To secure the window in the opening, the following steps should be taken:
 - a) Drill and countersink holes in the sliding panel channel. Make sure that the countersink is deep enough to accommodate your entire screw head, leaving it flush or slightly below the surface.
 - b) Slip the window into the opening with the bottom of the side channels setting on the base. Starting at the top, shim both sides with Cat. No. NWS9 Tapered Wood Shims (not included) so they are equally spaced in the opening. This can be easily accomplished by inserting the shims opposing each other (one from the outside and one from the inside). Gently push them together until you have filled the equally spaced gaps. Now secure the top of each side jamb with your Flat Head Screws (not included). Do not tighten the screws at this time, just snug them in place. Continue the shimming and securing process down both sides of the window, allowing the exact same space that you allowed at the top. After this procedure is completed, with clearances and squareness checked, gently tap the tapered shims together to achieve a tight fit. Tighten the screws. Now shim across the top of the window using the same procedures as listed above for both sides.
 - c) Check the operation of the window at this time. Does the window slide freely and stay in place when moved to a new position (if not, see Adjusting Window Tension Information on next page)? Also, check that the sliding latches operate properly (if not see Latching Information on next page). Do not use lubricant in jambs.
 - d) After everything is operating smoothly, take a CRL Cat. No. 199 Utility Knife (not included) and trim off any excess of Tapered Wood Shims (not included) protruding beyond the window frame.
 - e) Caulk around the perimeter of the frame with CRL Cat. No. M64 Construction Sealant (not included).
3. Clean the window thoroughly with CRL Cat. No. 1973 Glass Cleaner (not included) and CRL Cat. No. 1550 Lint Free Shop Towels (not included).

INSTALLATION PROCEDURES (FOR AN OUT OF SQUARE OPENING)

1. Read the above Installation Procedures (For Level and Plumb Openings). This will familiarize you with the steps needed to complete a proper installation. Then refer to Step 2 below for corrective actions if the opening is out of square.
2. If the counter/sill is not level but can be shimmed to a level position, all that is required is an opening above the counter/sill large enough to accommodate the frame set, with the jambs plumb and spaced evenly from top to bottom. Out of square side clearances can be compensated for with NWS9 Tapered Wood Shims (not included). If the counter/sill is level but the opening is out of square, you still only need a large enough opening above the counter/sill to accommodate the frame set, with the jambs plumb and spaced evenly from top to bottom.

NOTE: If you perform either of the above corrective actions, and find the the latches do not fully engage in the locked position because you don't have enough side clearance, a simple solution is to drill or chisel a recess in the jamb behind the latch deep enough to allow the latch to fully engage. However, if neither of the above solutions solve your out of square problem, re-work your opening, or call CRL for possible alternate solutions.

SW SERIES VERTICAL SLIDING SERVICE WINDOWS (SERIES 1000 THRU 1400)

INSTALLATION INSTRUCTIONS

Adjusting Window Tension

If there is not enough tension, your window has probably been installed out of square (refer to Installation Procedures for a Level and Plumb Opening with Proper Clearances). If you feel there is too much tension on the sliding window, you can adjust the tension by following the steps below: Do not use lubricant in jambs.

1. You will need to remove the sliding window from the side channels (this can only be accomplished by removing the entire window).
2. After removing the entire window, slide the sliding window portion out of the track from the bottom of the window.
3. On each side of the sliding window there is nylon runner strip, secured at the top and bottom with screws. Under the nylon runner strips are tension springs (the factory puts in enough of these springs to hold the window in place when it is moved). Each operator of the window has their own idea of what the proper tension should be, so adjustments may be made to meet the individuals needs. Reducing tension procedures are explained in step 4.
4. Remove the top or bottom screw that holds the nylon runner strip in place. You can now remove the tension springs. Remove as few of the springs as possible to get the desired tension, remembering that after the window has been used for a while the springs will lose some of their tension. Springs should always be removed in a balanced manner. **EXAMPLE:** if you have three tension springs under the nylon runner strip and want to remove one spring, remove the center one (this will provide equal tension on the top and bottom springs and prevent the window from binding). If you want to remove two springs, remove the two outer springs and leave the middle one in. **IMPORTANT:** Always remove equal amounts of springs from both sides of the sliding window, so the window will be centered between the jambs and allow the latches to operate properly.
5. After the desired tension has been achieved, re-install the window using the Installation Procedures.

LATCHING INFORMATION

Latch Handling is effortless when window is installed properly.

- To latch/lock, push latch button down and then slide towards the outside of the window. A click sound indicates that window is properly latched.
- To unlatch/unlock, push latch button down and then slide towards the inside of the window.

Be aware that any deviation in the installation process might affect latch operation and can cause problems (see procedure for proper installation).

Latch will be inoperable whenever:

- Wall opening is not square, true, and right size.
- Window unit is not plumb and square.
- Aluminum parts are not aligned and straight.
- Lock slots in the frame are not free of obstruction. The lock will not operate correctly if dirt/sealant/etc... is allowed to build up in the slot.

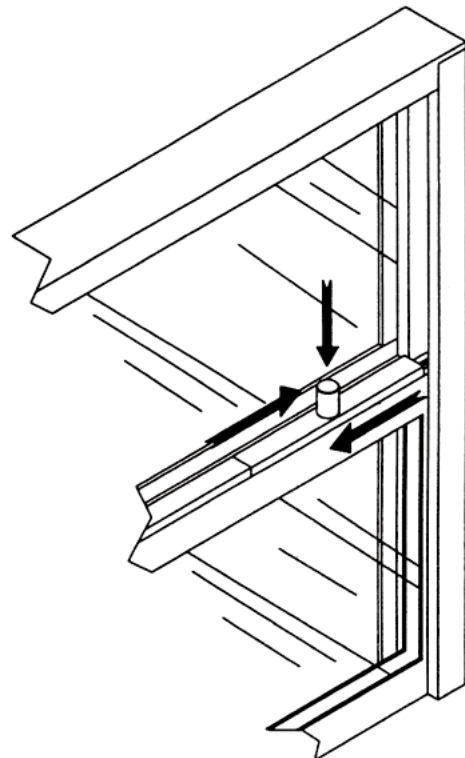

SW SERIES VERTICAL SLIDING SERVICE WINDOWS (SERIES 1000 THRU 1400)

INSTALLATION INSTRUCTIONS

WINDOWS WITH SASH BALANCES

Units 1050 square inches or more require a concealed top sash balance. Sash balances are provided with specific tension only and are not adjustable. If the sash balance cables bind up, you can attempt to release this binding. If the cable tension cannot be released, contact CRL. If sash does not work smoothly, follow these instructions:

1. Remove top cover plate exposing sash balances.

The plate may be removed either from the outside or inside of the unit. The face of the sash balance will look like the type "AT" or "FT".

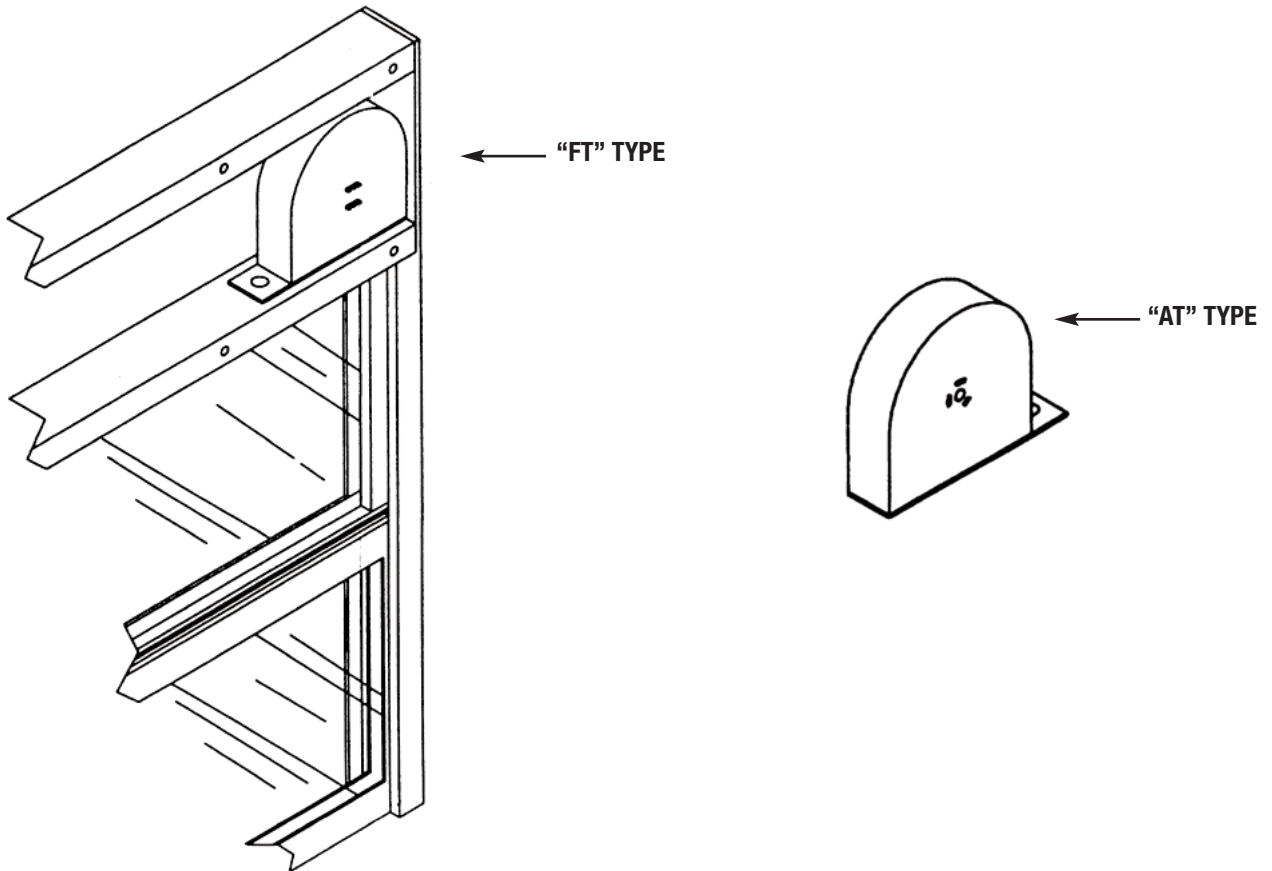

2. To release some of the cable binding, place a punch in the hole of the "AT" type sash balance and tap the punch with a mallet or hammer. On the "FT" type sash balance use a screwdriver and mallet or hammer to tap the two saw-toothed fasteners on the balance. **Only a gentle tap is necessary to ease the cable tension.**

3. Raise and lower the sash a few times to test its operation and replace cover plate.

SW SERIES VERTICAL SLIDING SERVICE WINDOWS (SERIES 1000 THRU 1400)

INSTALLATION INSTRUCTIONS

GLAZING PROCEDURES

If you purchased your service window without glass, follow the glazing guidelines listed below. Two glazing guidelines are shown; one for units without a sash balance, one for units with a sash balance. Please choose the appropriate glazing procedures based on your unit. If you have questions, please call C.R. Laurence for assistance.

WINDOWS WITHOUT SASH BALANCE

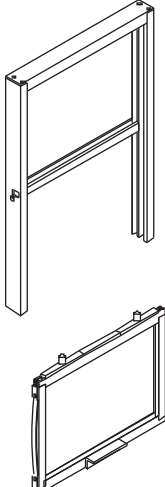
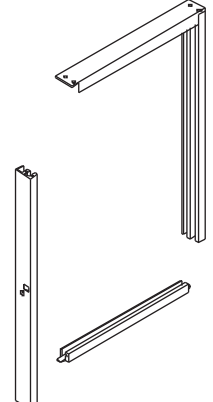
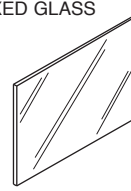
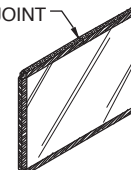
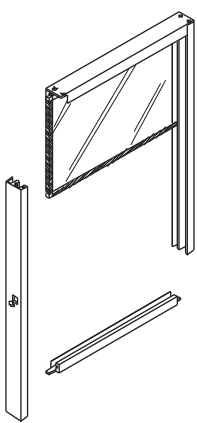
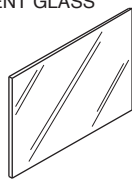
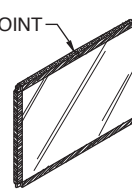
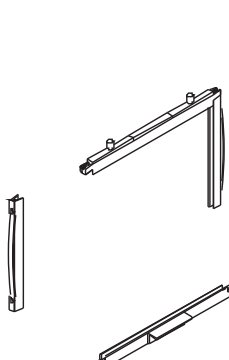
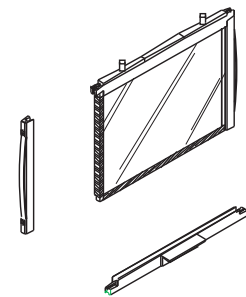
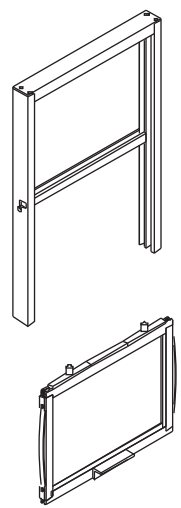
| | | | |
|---|---|--|---|
|  <p>SLIDE VENT OUT OF FRAME. * IF WINDOW HAS SCREEN, SLIDE SCREEN OUT AND SET ASIDE.</p> |  <p>REMOVE 1 JAMB. REMOVE MULLION (4 SCREWS).</p> | <p>FIXED GLASS</p>  <p>JOINT</p>  <p>WRAP WITH FIXED VINYL. JOINT SHOULD BE IN MIDDLE OF TOP.</p> |  <p>PUSH HEAD AND JAMB ON TO WRAPPED GLASS. PUSH MULLION AND REMAINING JAMB INTO PLACE. SCREW FRAME TOGETHER.</p> |
| <p>VENT GLASS</p>  <p>JOINT</p>  <p>WRAP WITH VENT VINYL. JOINT SHOULD BE IN MIDDLE OF TOP.</p> |  <p>REMOVE 1 STILE. REMOVE BOTTOM RAIL (3 SCREWS).</p> |  <p>PUSH TOP RAIL AND STILE ON TO WRAPPED GLASS. PUSH OTHER STILE AND BOTTOM RAIL INTO PLACE. SCREW FRAME TOGETHER.</p> |  <p>SLIDE VENT INTO FRAME. * IF WINDOW HAS SCREEN, SLIDE SCREEN INTO FRAME.</p> |

**SW SERIES VERTICAL SLIDING SERVICE WINDOWS
(SERIES 1000 THRU 1400)**

INSTALLATION INSTRUCTIONS

WINDOWS WITH SASH BALANCE

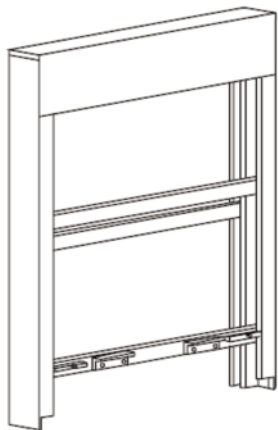

REMOVE FRONT AND BACK COVER PLATES. NUMBER OF SCREWS DEPENDS ON WINDOW WIDTH. NOTE: IDENTIFY BACK AND FRONT COVER PLATES FOR EASIER REINSTALLATION. REMOVE TOP HEAD (A) (4 SCREWS). LOOSEN BOTTOM HEAD FROM FRAME (B) (4 SCREWS).

SLIDE VENT UNIT OUT OF TOP OF FRAME (WITH ATTACHED BOTTOM HEAD (B) AND SASH BALANCES). *IF WINDOW HAS A SCREEN, SLIDE SCREEN OUT AND SET ASIDE.

REMOVE 1 JAMB (2 SCREWS).

FIXED GLASS

WRAP WITH FIXED VINYL. JOINT SHOULD BE IN MIDDLE OF TOP.

PUSH JAMB AND MULLION ONTO WRAPPED GLASS. PUSH JAMB INTO PLACE. SCREW FRAME TOGETHER.

VENT GLASS

WRAP WITH VENT VINYL. JOINT SHOULD BE IN MIDDLE OF TOP.

REMOVE BOTTOM RAIL (2 SCREWS).

PUSH JAMB AND HEAD ONTO THE WRAPPED GLASS. PUSH BOTTOM RAIL INTO PLACE. SCREW FRAME TOGETHER.

SLIDE VENT UNIT INTO THE FRAME. SECURE BOTTOM HEAD (B) TO THE FRAME * IF WINDOW HAS A SCREEN, SLIDE THE SCREEN INTO FRAME.

SCREW TOP HEAD TO THE FRAME. SCREW FRONT AND BACK COVER PLATES. WINDOW IS READY TO BE INSTALLED.